

4) Fast play: Touch on this icon to watch the previous movie played.



5) Refresh: Touch the icon to refresh the files.



6) Search: Touch the icon, and enter the video file name in the browse, and get the video straight out..



7) More: Touch this icon to pop up below window:

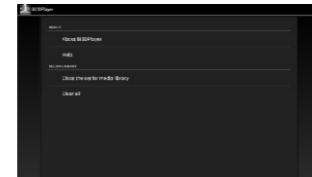

1. About 3Dplayer: Information about 3Dplayer.
2. Help: Open the 3DPlayer help file.
3. Clear media directory settings: Erase all videos displayed, while maintaining thumbnail image and directories.
4. Clear all: Erase all contents, including video directories, thumbnail images, and return to the initial interface.

12. Add videos

1) To add image by [scan all], the software will scan all video files stored on TF card and Nand flash.

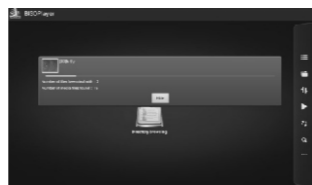
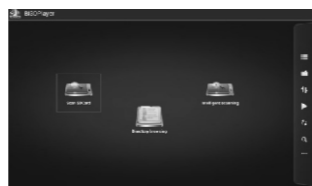

After scanning, the interface will be showed in Gallery mode or in List mode, like below:



2)To add videos by "Smart Scan" , insert the TF card and refresh, and confirm that there is no video files in Nand flash. Click [Smart scan]:

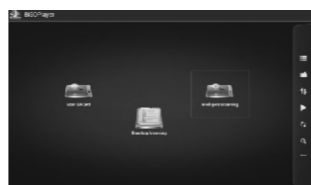

Select the directory to be scanned and click [scan]:



Results as below:



13. Delete videos

Delete videos with functions of [Clear media directory settings] or [clear all] from [MORE]. Click the "more" icon , touch[Clear media directory settings] or [clear all], to erase all video information..

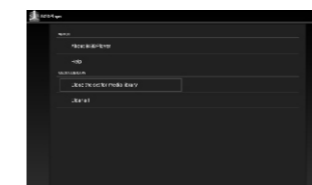

14. Search videos
Touch the "search" icon from the toolbar, and enter searching interface. Type the name of the video and then search.



15. Interface introduction and video playing

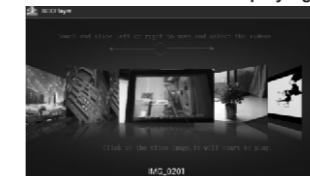

(Gallery mode): Touch and slide left or right to move and select the videos. Click on the video image, it will start to play.



(List Mode)Touch and slide up or down to select the videos. Click on the video image, it will start to play..

16. WIFI setup



(Icon mode) Touch and slide to the right to select videos.

10.1 Turn on WIFI

Click to enter setup menu, select "On" in Wi-Fi option, as shown in figure below:

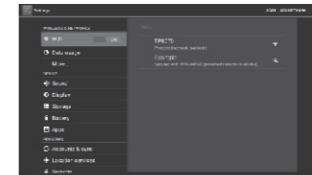

10.2 WIFI setting and WIFI network
Click "Scan", system will search WIFI network automatically, and display signal strength.

10.3 IP address setting and connecting: two ways

A. Auto Obtain IP address:
System default is IP address auto obtaining, click the target network name, input password if it is required to, click "KW" network as picture below to pop up Password Input Window; input right password, and click it; after through KW network's verification, system will auto obtain IP address from KW network, as shown in figure below:



B. Manually Obtain IP address:
Place a check mark in "Advanced" , and select "Static" in "IP setting" ; click "connect" and the setting will be effective.

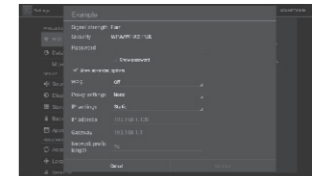

Disclaimer: We try to ensure its correctness and integrity of the manual, but it is hard to avoid any mistake and omission. Please take material object as the standard. Our company is derelict of duty for mistake and omission that may exist.



1. Accessory list

Power adapter-----	1 pc
User's manual-----	1 pc
USB cable-----	1 pc
USB Host Converter Adapter Cable -----	1 pc

2. Mainframe introduction

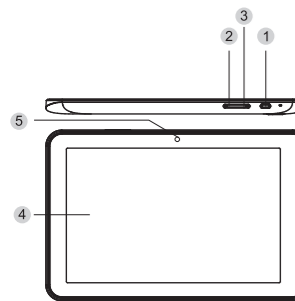

- 1 Power: a.long press it to turn on or pop up Shutdown windows;
b.press it to enter standby mode or exit
c.long press for 6s to turn off
- 2 Volume-: decrease the volume
- 3 Volume+: increase the volume
- 4 Screen: Capacitive Touch Screens
- 5 Camera: front camera

1

3. Interface introduction

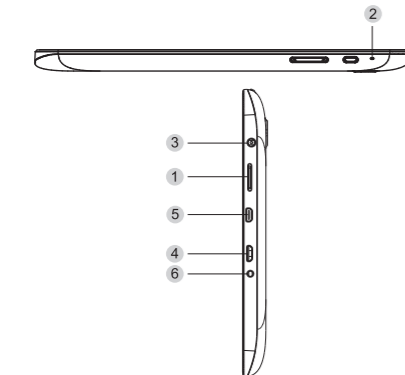

- 1 Micro SD: insert Micro SD card;
- 2 MIC: can do record and chat on line by third-party software;
- 3 Earphone: connect to earphone to output stereo;
- 4 USB OTG: a, connect to PC to transfer data;
b, connect to USB flash drive , HDD or others through USB Host Cable, (External power is needed.);
c, connect to USB power adapter or PC to charge the device;
- 5 HDMI: HD output; can connect to TV, monitor or other similar devices with HDMI input interface;
- 6 Power Input: connect to power adapter, DC 5V/2.0V input.

2

4. Peripheral Connection

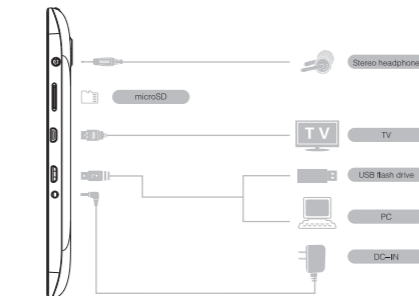

5. Turn on/off

5.1 Turn on and unlock the screen
In Power off mode, long press "POWER" button to enter Android system' s Boot screen; after enter the desktop, touch and drag the icon to unlock, as shown in figure below:

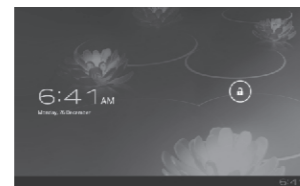

5.2 Power saving mode and lock the screen
After power on, press "POWER" button to enter SLEEP power saving mode, the screen turns to black and enters to lock state, press "POWER" button again to unlock and the screen turns to bright.

3

5.3 Turn off

In power on state, long press "POWER" button to pop up Shutdown confirmation portal, select "Confirm" to turn off the device

Note: when the device is in low battery, there is a continuous alarm, and it will automatically power off if you don't charge it; if you can not turn on the device, check whether the battery is enough; make sure there is a certain battery reserve, then try to turn on the device.

6. 3D Video Playback(Applicable only to 3D models.)
BPlayer prepared in the model can help play 3D videos, and 2D videos are also compatible. When entering application interface, click the BPlayer icon to play the 3D videos. (Please rename your video files with a [3D] before your file names before you play the 3D videos, for the player will only run and realize the glasses-free 3D video playback when the file names of your 3D videos begin with a [3D].)

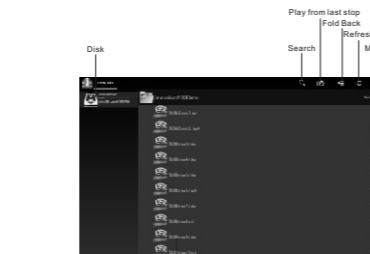

When playing 3D videos, you can adjust the brightness of the screen by sliding it up and down in the left side, and the volume of the videos by sliding the screen up and down in the right side.

4



7. 3D Picture Playback(Applicable only to 3D models.)
Bpicture prepared in the model can help play 3D pictures, and 2D pictures are also compatible. When entering application interface, click the BPicture icon to play the 3D pictures. (Please rename your picture files with a [3D] before your file names before you play the 3D pictures, for the player will only run and realize the glasses-free 3D picture playback when the file names of your 3D pictures begin with a [3D].)

When playing 3D pictures, you can adjust the brightness of the screen by sliding it up and down in the left side, and the rapidity of the pictures by sliding the screen up and down in the right side. In horizontal orientation, viewing the next picture by sliding the screen to left side and the previous picture to right side.



5

8. User Interface

8.1 Main Interface
Turn on and unlock the screen, then enter Main Interface as below:



Icons	Captions
	Return
	Main Interface
	Back Stage
	Function Menu
	Show battery level
	Wifi state
	Setting
	Refresh
	Brightness Adjustment
	Time
	Date

6

8.2 Function menu

Click in Main Menu to enter function menu



8.3 Widget



8.4 Operation background

Click to look into background operation situation.

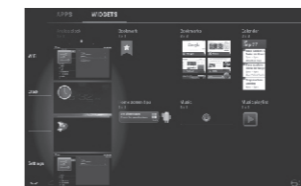

7

9. Battery management and charging

A. Before first operation, the unit should be recharged for 5~6 hours to make sure the battery is fully charged.

B. Connect the Power adapter to the device; the battery icon on desktop displays as , and green bar is rolling, which means the device is charging. Don't unplug the charger in charging. After fully charged, the battery icon on desktop displays as , and the green bar stops rolling.

Note: Lithium battery doesn't need to recharge after power fully runs out.

10. Introduction

3Dplayer is an Android application for decoding of most 2D/3D video contents. It will easily browse the video files stored in flash memory or in TF card, effectively gather detailed video information, and then present it to users under a friendly interface. It supports internal and external subtitle, no matter in image or in text format..

11. Toolbar introduction

1) Interface switch: to switch between "Gallery" interface and "Video List" interface..



8



2) Directory Browse: Click on the icon in the toolbar and enter into directory browse window.



Touch the sdcard directory, and then the folders below, video files inside will be displayed.



Touch on the icon in the toolbar. all folders opened will be gathered back.

9



3) Sequence: Touch the [sequence] icon in toolbar, a dialog window shall pop out. You can choose to sort the video files under various manners, like file directory, file name, file size, file format, last edited time, length of video and resolution.

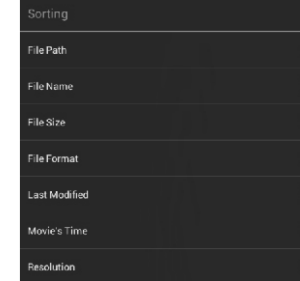

10