



This device complies with Part 15 of the FCC Rules.

Operation is subject to the following two conditions:

- (1) This device may not cause harmful interference, and
- (2) This device must accept any interference received, including interference that may cause undesired operation.

**Warning:** Changes or modifications to this unit not expressly approved by the party responsible for compliance could void the user's authority to operate the equipment.

**NOTE:** This equipment has been tested and found to comply with the limits for a Class B digital device, pursuant to Part 15 of the FCC Rules.

These limits are designed to provide reasonable protection against harmful interference in a residential installation. This equipment generates, uses and can radiate radio frequency energy and, if not installed and used in accordance with the Instructions, may cause harmful interference to radio communications.

However, there is no guarantee that interference will not occur in a particular installation. If this equipment does cause harmful interference to radio or television reception, which can be determined by turning the equipment off and on, the user is encouraged to try to correct the interference by one or more of the following measures:

- Reorient or relocate the receiving antenna.
- Increase the separation between the equipment and receiver.
- Connect the equipment into an outlet on a circuit different from that to which the receiver connected.
- Consult the dealer or an experienced radio/TV technician for help.

#### LIMITATION OF LIABILITY

*Liability limited to the purchase price of this product. Telebrands Corp. shall not be liable for any incidental or consequential damages or any implied warranty on this product. Some states do not allow the exclusion or limitation of incidental or consequential damages, so the above limitation or exclusion may not apply to you.*

Manufactured for  
**TELEBRANDS**  
Fairfield, NJ 07004  
©2016 Telebrands  
www.telebrands.com

#### ⚠ WARNING

- Store out of reach of children. This product is not a toy. Close supervision is required when any appliance is used by or near children.
- To protect against the risk of electric shock, do not put the battery charger in water or other liquids. Do not charge battery if it is wet or shows signs of corrosion.
- Do not use an extension cord. Plug the charger directly in to a standard 120V power outlet.
- Do not charge this unit outdoors.
- Do not attempt to use this charger with any other product. Do not attempt to charge this product with any other charger.
- If the charging cord is damaged, it must be replaced by the manufacturer or its service agent or similarly qualified person in order to avoid hazard.
- Do not use this charger in wet or damp conditions. It is intended for indoor use only. Do not use charger near sinks or tubs. Do not immerse in water.
- Do not abuse the cord. Do not carry the charger by the cord or yank the cord to disconnect. Keep charging cord away from heat and sharp edges.
- Do not allow the cord to hang over the edge of a table or counter or touch hot surfaces. The charger should be placed away from sinks and hot surfaces.
- Unplug the charger when not in use and before cleaning.
- Do not operate adapter if it has received a sharp blow, been dropped or otherwise damaged in any other way. Do not disassemble the adapter for any reason.
- For best results do not charge a battery when it or the air temperature is below 40 F (5 C) or above 105 F (40 C).
- Always store this unit indoors.
- Do not operate in the presence of explosives and/or other flammable fumes or liquids.
- Do not store or use the appliance close to high temperatures.
- If abnormal noise, smell, smoke or any other failure or breakage is found during operation, turn off the switch and unplug it.
- Only charge the unit when it is in the OFF position.
- This appliance is only for household use, not for commercial or industrial use.
- Always use proper eye protection when using this unit with irritating substances. Rubber gloves are also recommended.
- Only change the scrubber heads when the unit is in the off position.
- Keep hair, loose clothing and all parts off the body away from the moving parts of the unit.
- Do not use this unit when the protective charging cover is not in place. Do not submerge the handle in water or other liquids.
- To avoid risk of suffocation, keep all plastic bags away from children.

## PRODUCT INFORMATION

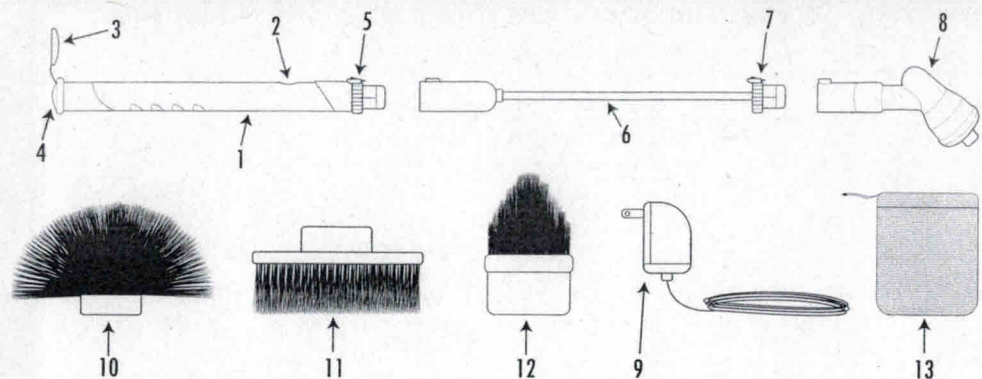

- |                                    |  |
|------------------------------------|--|
| 1. Main Handle                     | 7. Top Extension Release Button                    |
| 2. ON/OFF Switch                   | 8. Scrubber Head Assembly                          |
| 3. Charging Cover                  | 9. Charging Adapter                                |
| 4. Charging Port                   | 10. Dome Brush Head                                |
| 5. Bottom Extension Release Button | 11. Flat Brush Head                                |
| 6. Extension Handle                | 12. Corner Brush                                   |
|                                    | 13. Mesh Storage Bag* For Brush Heads (11"x14.25") |

## HANDLE ASSEMBLY

Before assembling any component of this product, make sure the unit is set to the OFF position.

### ASSEMBLY WITHOUT EXTENSION HANDLE

Connect the Main Handle to the Scrubber Head Assembly until you hear a "CLICK".

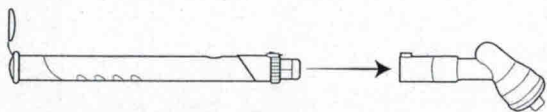

### ASSEMBLY WITH EXTENSION HANDLE

Connect the Main Handle to the Extension Handle until you hear a "CLICK".

Next, connect the Scrubber Head Assembly to the extension handle until you hear a "CLICK".

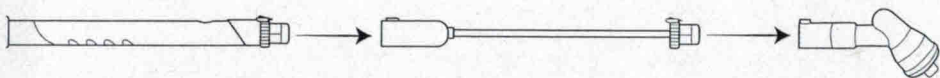

## BRUSH HEAD ASSEMBLY

- Firmly hold the Scrubber Head Assembly with one hand and then press the selected scrubber head on until secured.

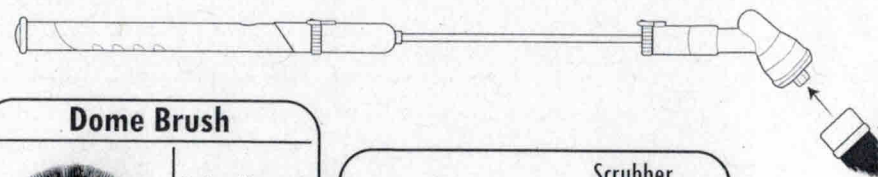

### Dome Brush



Perfect all around cleaning brush.

### Flat Brush

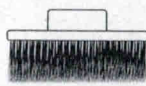

Ideal for large jobs with lots of flat surface area.

### Corner Brush



Great for cleaning grout, corners and tight places.

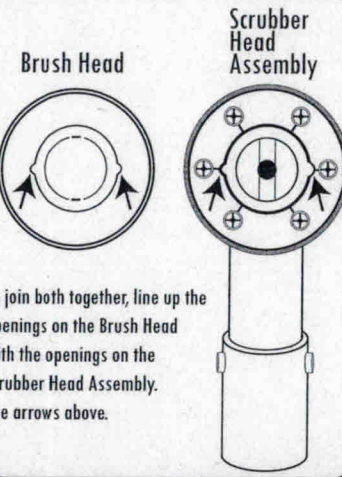

To join both together, line up the openings on the Brush Head with the openings on the Scrubber Head Assembly. See arrows above.

## OPERATION

- CAUTION:** Before turning on the brush, make sure to use proper eye wear and gloves to avoid eye and skin contact from splatter.



- Apply water and a cleaning agent to the surface needing cleaning and/or the head of the Hurricane® Spin Scrubber™ brush.
- To start cleaning, turn the button to the ON position while the scrubber head is in contact with the desired cleaning surface. Hold the unit by its handle and gently press the scrubbing head to the surface to be cleaned. Do not press too hard. The product has been specially designed to do all the work.
- Operate Hurricane® Spin Scrubber™ brush only when it is touching the area being cleaned in order to limit spraying of water.
- Cleaning chemicals should be used only in accordance with instructions of manufacturer of the surface being cleaned. Abrasive cleaners should never be used.
- First try the brush on an inconspicuous surface.

## Battery Removal

This product uses a Nickel-Cadmium (Ni-cad) rechargeable battery. When the battery can not be recharged anymore it should be removed from the unit and recycled properly. This battery can not be incinerated or composted.



1. Using a phillips head screwdriver, remove the left and right side screws, as shown in Figure 1.
2. Grasp the bottom of the handle and the top part of the unit and pull the battery assembly out, as shown in Figure 2.
3. Peel away the tape, unclip the red and black wires, and take out the battery, as shown in Figure 3.

FIGURE 1

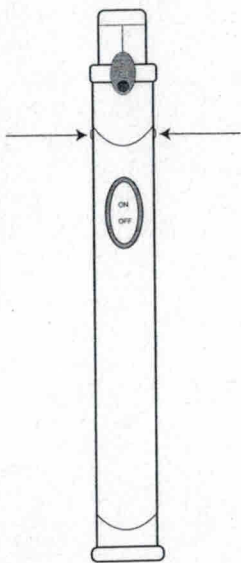

FIGURE 2

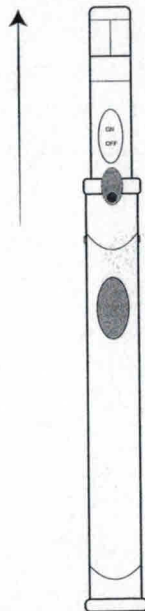
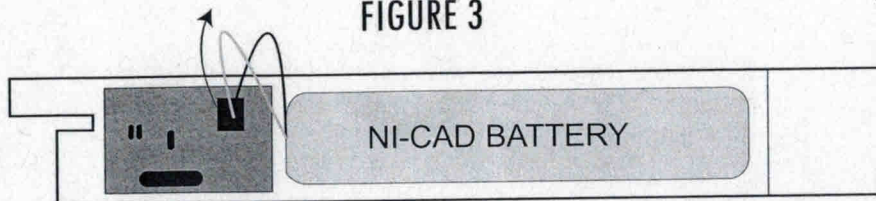

FIGURE 3



## MAIN UNIT CLEANING

- Clean all surfaces of the unit with a soft cloth.
- Only use a mild detergent to clean the unit. Do not use alcohol-based or abrasive cleaners.
- Aside from the unit's brush head, do not submerge it, or shower it, in water.
- Separate all sections of the unit and allow it to air dry.

## CHARGING

- Charging requires that the ON/OFF button be set to OFF.
- Insert the Charging Adapter into the Charging Port located at the bottom of the unit.  
A RED indicator light means charging is occurring.
- Your first charge requires 20 hours, but later charges take only 8 hours.
- If the unit does not charge, test the wall outlet that you are using with a known working device.  
Also, if the wall outlet is connected to a wall switch, check and see that the switch is turned to the ON position.
- If the unit's handle feels warm during charging, don't worry this is completely normal.
- Close the Charging Cover once charging is complete.
- Keep the device OFF during the charging process.
- Do not separate the Charging Cover from the device.
- Do not worry, you can not over-charge the battery by using the provided charging adapter.

